



GALİPOĞLU®
HIDROMAS

Phone : 90.332 239 08 52 (pbx)

Fax : 90.332 239 08 51

Mail : hidromas@hidromas.com

Address : Büyükkayacık Mah. Konya O.S.B. 3 Nolu Sk No:1/A 42250

SELÇUKLU / KONYA

TÜRKİYE

GHS 175-5-7100 C TEL.SİL.

Product Code :

43175571003

Reference No :

01-001

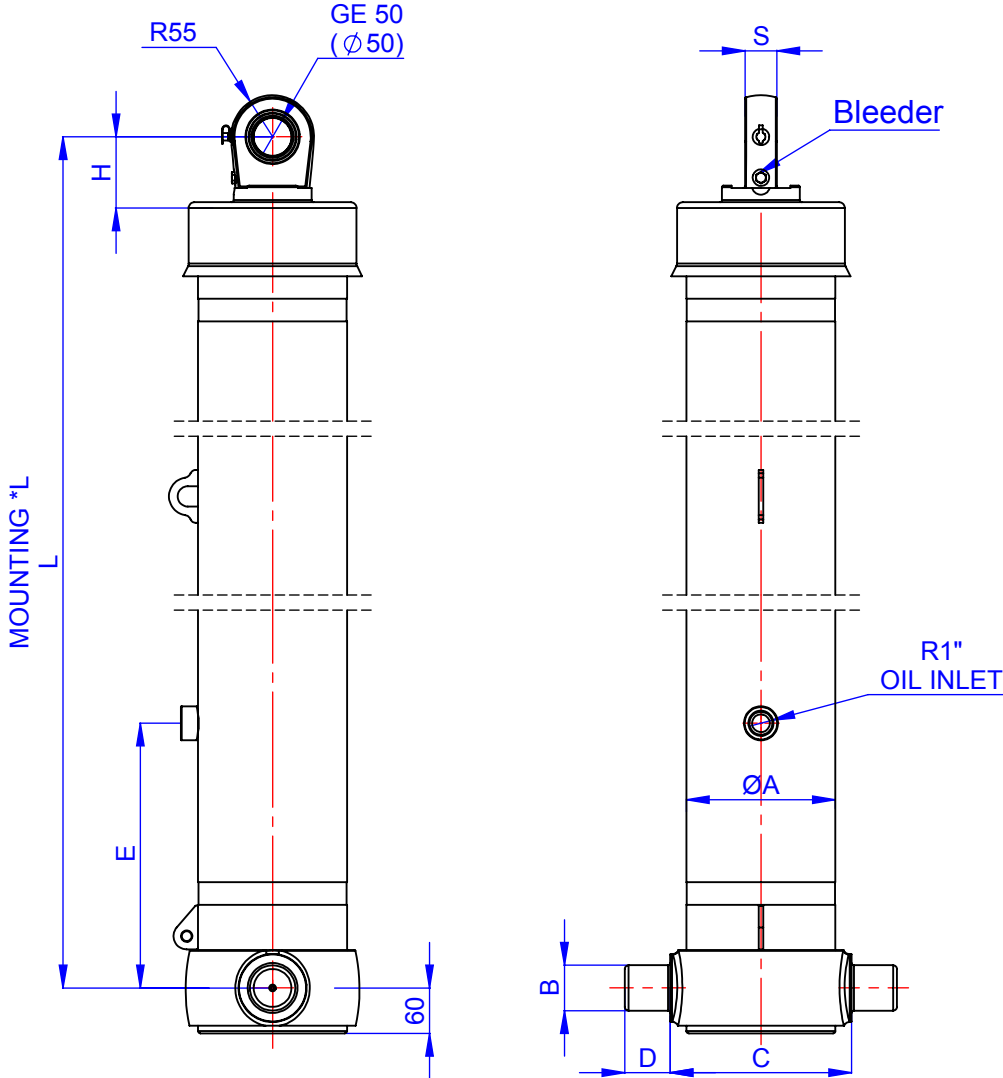

A :	197
B :	60
C :	240
D :	60
E :	350
F :	
G :	
H :	94
I :	
J :	
K :	
L :	1747
*L :	1777
M :	
N :	
O :	
P :	
R :	
S :	42
S1 :	
T :	
U :	
V :	
W :	
Y :	
Z :	

EFFECTIVE DIAMETER (mm)				175	155	135	116	98			
STROKE (mm)				1420	1420	1420	1420	1420			
THRUST AT 170 BAR (TONS)				40.5	31.7	24.1	17.8	12.7			

All sizes were given as mm

SPECIFICATIONS

- Stroke : 7100
- *Inc 30 mm pull out : Tolerance +20 ; 0
- Working pressure : 170 Bar
- Max. working pressure : 190 Bar
- Working Temperature : -23 °C / +80 °C
- Total Volume : 125 L
- Weight Cylinder : 277.0 kg
- Hard cromed all stages
- All cylinder materials are st 52 cold down tubes
- Standard cylinder is painted with RAL 1036

FORMULATION

- St : (Stroke)
- BL : (Body Length)
- Ro : (Rear Overhang)
- PI : (Pivot Length)
- C : (Bracket Length)

$$\alpha^\circ = \frac{St \times 60}{PI}$$

