



GALİPOĞLU®
HIDROMAS

Phone : 90.332 239 08 52 (pbx)

Fax : 90.332 239 08 51

Mail : hidromas@hidromas.com

Address : Büyükkayacık Mah. Konya O.S.B. 3 Nolu Sk No:1/A 42250

SELÇUKLU / KONYA

TÜRKİYE

GHS 155-4-3680 C TEL.SİL.

Product Code :

43155436803

Reference No :

01-001

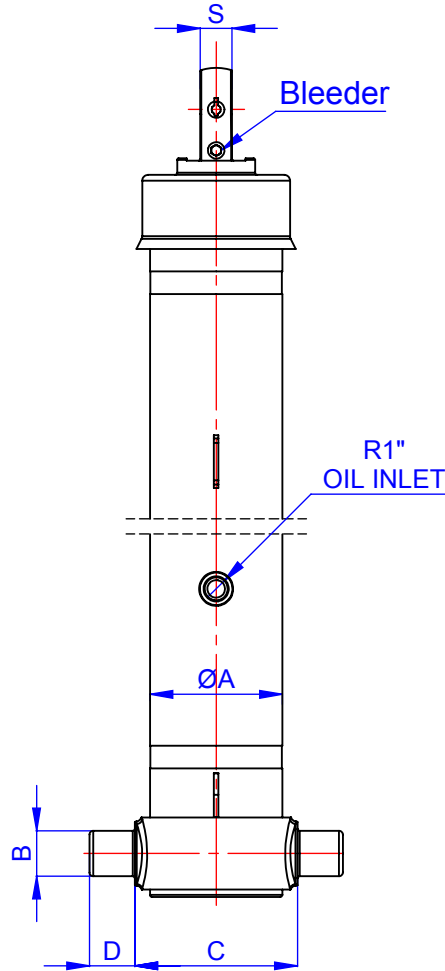
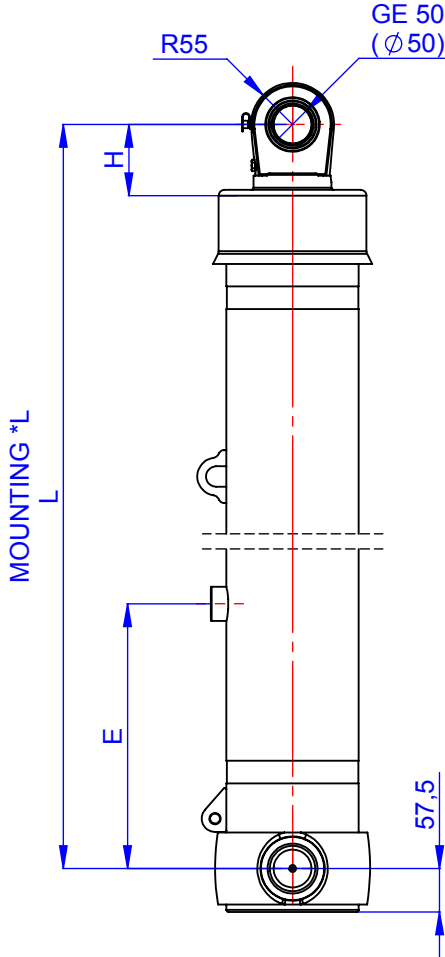

A :	175
B :	60
C :	215
D :	60
E :	350
F :	
G :	
H :	94
I :	
J :	
K :	
L :	1179
*L :	1209
M :	
N :	
O :	
P :	
R :	
S :	42
S1 :	
T :	
U :	
V :	
W :	
Y :	
Z :	

EFFECTIVE DIAMETER (mm)					155	135	116	98			
STROKE (mm)					920	920	920	920			
THRUST AT 170 BAR (TONS)					31.7	24.1	17.8	12.7			

All sizes were given as mm

SPECIFICATIONS

- Stroke : 3680
- *Inc 30 mm pull out : Tolerance +20 ; 0
- Working pressure : 170 Bar
- Max. working pressure : 190 Bar
- Working Temperature : -23 °C / +80 °C
- Total Volume : 57.1 L
- Weight Cylinder : 144.7 kg
- Hard cromed all stages
- All cylinder materials are st 52 cold down tubes
- Standard cylinder is painted with RAL 1036

FORMULATION

- St : (Stroke)
- BL : (Body Length)
- Ro : (Rear Overhang)
- PI : (Pivot Length)
- C : (Bracket Length)

$$\alpha^\circ = \frac{St \times 60}{PI}$$

