

GHS 155-4-5140 C TEL.SİL.

Product Code : 43155451403

Reference No : 01-001

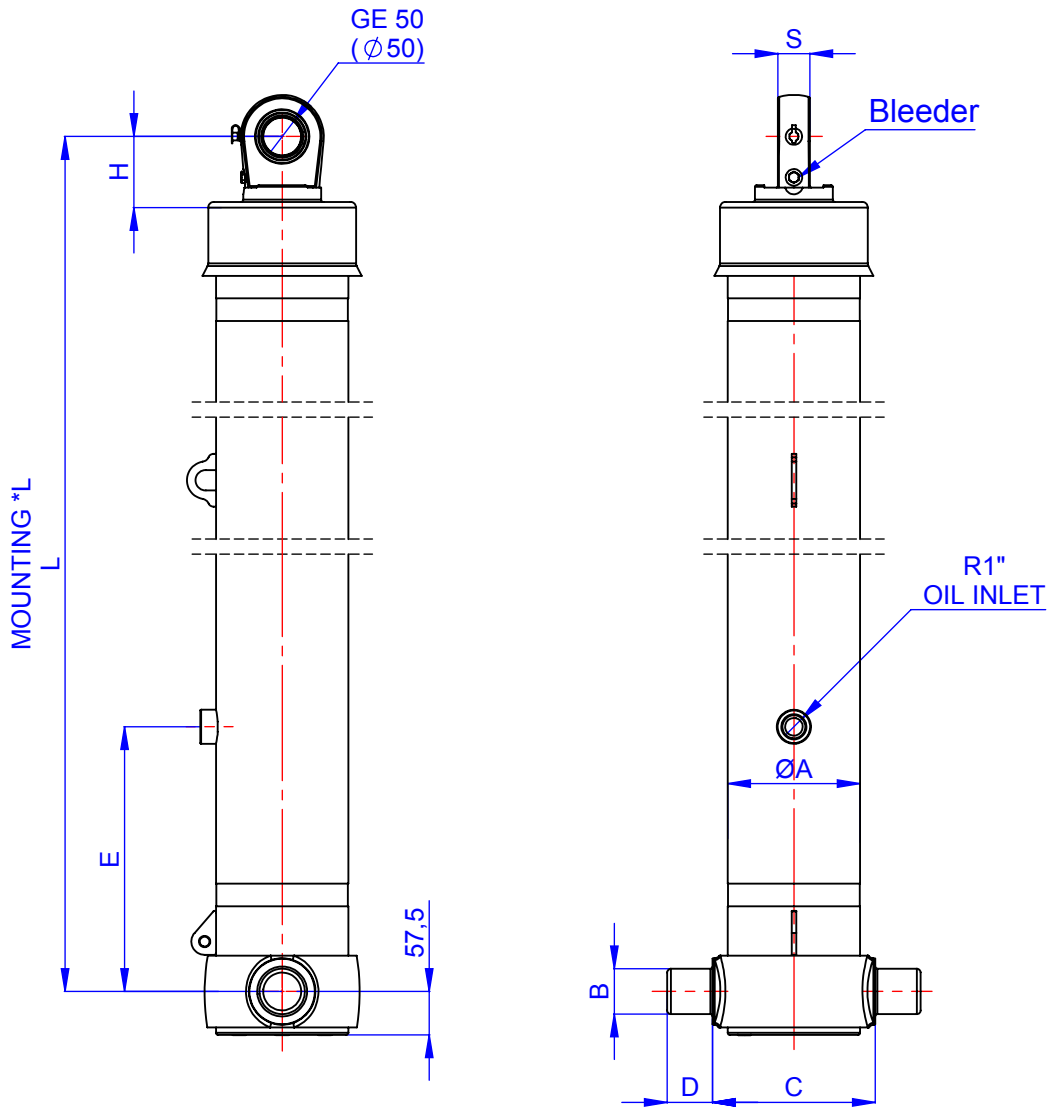

A	: 175
B	: 60
C	: 215
D	: 60
E	: 350
F	:
G	:
H	: 94
I	:
J	:
K	:
L	: 1599
*L	: 1629
M	:
N	:
O	:
P	:
R	:
S	: 42
S1	:
T	:
U	:
V	:
W	:
Y	:
Z	:

EFFECTIVE DIAMETER (mm)					155	135	116	98			
STROKE (mm)					1285	1285	1285	1285			
THRUST AT 170 BAR (TONS)					31.7	24.1	17.8	12.7			

All sizes were given as mm

SPECIFICATIONS

- Stroke : 5140
- *Inc 30 mm pull out : Tolerance +20 ; 0
- Working pressure : 170 Bar
- Max. working pressure : 190 Bar
- Working Temperature : -23 °C / +80 °C
- Total Volume : 79.8 L
- Weight Cylinder : 192.4 kg
- Hard cromed all stages
- All cylinder materials are st 52 cold down tubes
- Standard cylinder is painted with RAL 1036

FORMULATION

- St : (Stroke)
- BL : (Body Length)
- Ro : (Rear Overhang)
- PI : (Pivot Length)
- C : (Bracket Length)

$$\alpha^\circ = \frac{St \times 60}{PI}$$

